

Miele

Operating and Installation instructions

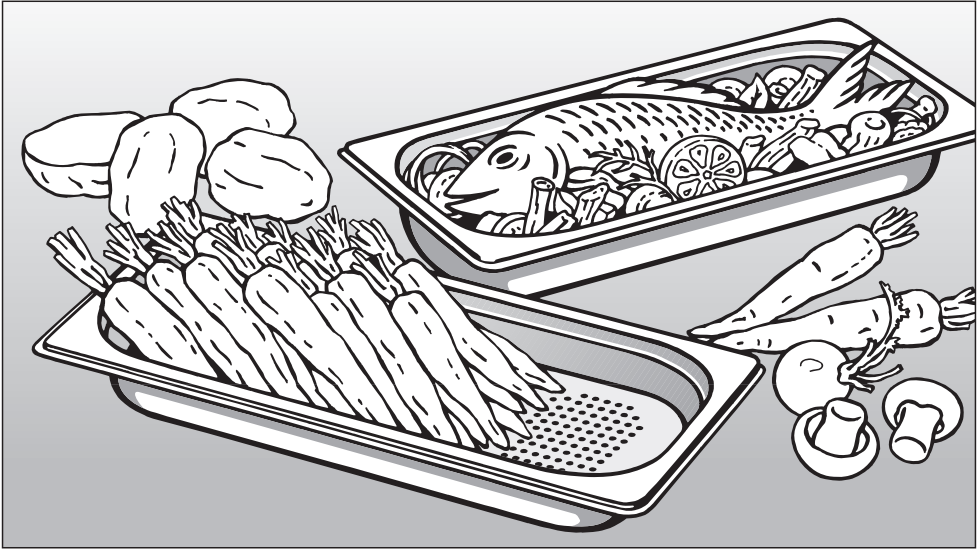

Steam oven
DG 4050
DG 4060



To avoid the risk of accidents or damage to the appliance it is **essential** to read these instructions before it is installed and used for the first time.



M.-Nr. 06 159 580

Contents

Guide to the appliance	5
Front view	5
Accessories supplied	6
Optional accessories	7
Warning and Safety instructions	9
Caring for the environment	15
Using for the first time	16
Setting the water hardness	18
Cleaning and heating up for the first time	20
Operation	21
Controls	21
Night dimming	21
Operating sequence	22
Changing the time of day	24
Minute minder	25
Recommended temperature	27
Before each use	28
Selecting a steam oven function	29
Selecting a temperature	29
Setting a cooking duration	30
Starting a programme	31
Saving settings	32
Interrupting a programme	32
Changing the settings during operation	33
At the end of the cooking duration	34
After use	35
Automatic	36
User programmes	37
Delay start	39

Safety features	40
Lock (LOCK )	40
System lock (SYSTEM LOCK )	41
Solo Programme	42
Changing settings	44
Language 	44
Clock	45
Main menu	45
Start	45
Keeping warm	46
Temperatures	46
Water hardness	46
Display	47
Buzzer tones	47
Safety	47
Units	47
Demo mode	48
Factory default	48
Practical tips	49
Suitable containers	49
Steaming	50
Reheating	55
Defrosting	56
Bottling	58
Cooking whole meals	59
Blanching	60
Preparing yoghurt	60
Disinfecting baby bottles	61
Cleaning and care	62
General notes	62

Contents

Appliance front and control panel	63
Removing the steam oven door	64
Oven interior	65
Condensate tray, rack and cooking containers	65
Automatic door release	65
Side runners	65
Water container	66
Coupling seal	67
Descaling	68
Problem solving guide	70
After sales service, data plate	72
Installation	73
Safety instructions for installation	73
Appliance and building-in dimensions	74
Installing the appliance	77
Electrical connection	78

Front view

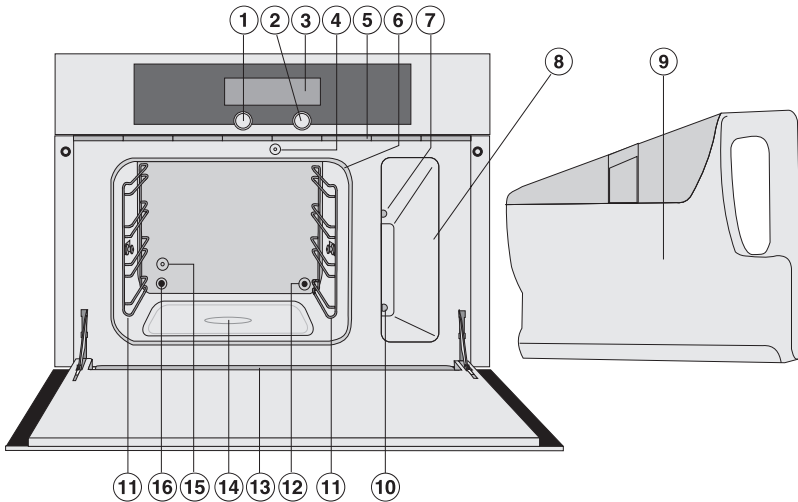

- ① On/Off switch (retractable)
- ② Multi-function selector with turn and press mechanism (retractable)
- ③ Display
- ④ Automatic door release for reducing steam
- ⑤ Ventilation outlet
- ⑥ Door seal
- ⑦ Steam channel
- ⑧ Compartment for steam generator
- ⑨ Steam generator (with insert)
- ⑩ Contact point
- ⑪ Side runners with 4 shelf levels
- ⑫ Steam inlet
- ⑬ Drip channel in the oven
- ⑭ Floor heater
- ⑮ Temperature sensor
- ⑯ Outlet for air from oven interior

Guide to the appliance

Accessories supplied

Additional accessories can be ordered at extra cost. See "Optional accessories".

Condensate tray

To catch excess moisture
Gastronorm size GN 2/3
325x350x40 mm (WxDxH)

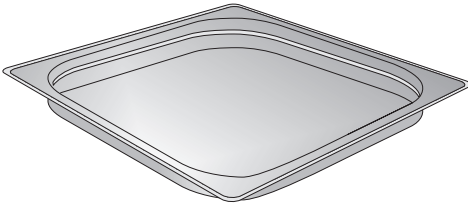

1 cooking container DGGL 8, perforated (gross capacity 2.0 litres / usable capacity 1.7 litres)

For steaming
Gastronorm size GN 1/2
325x265x40 mm (WxDxH)

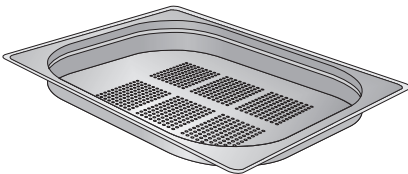

Miele steam oven cookbook

A selection of the best recipes from the Miele test kitchen.

2 cooking containers DGGL 1, perforated (gross capacity 1.5 litres/ usable capacity 0.9 litres)

For steaming
Gastronorm size GN 1/3
325x175x40 mm (WxDxH)

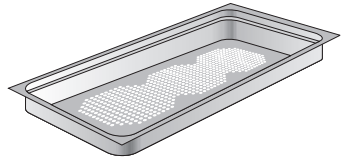

Rack

For placing cooking containers on

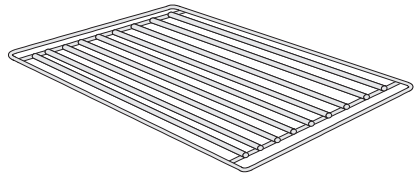





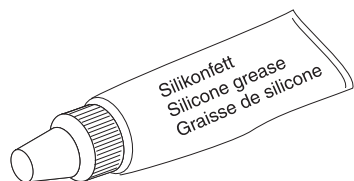

Silicone grease

For lubricating the coupling seal
Please read the relevant instructions in "Cleaning and care".

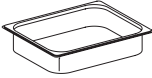

Optional accessories

Stainless steel containers

Description	Use	Gross / usable capacity in litres	Height in mm	Width x Depth in mm
 DGG 2 solid (GN 1/3)*	For dishes in sauces and for cooking dried foods like pasta and rice in liquid	2.5 / 2.0	65	325 x 175
 DGG 3 solid (GN 1/2)	as DGG 2, but deeper	4.0 / 3.1	65	325 x 265
 DGGL 4 perforated (GN 1/2)	For steaming vegetables, fish and meat which is not being cooked in a sauce	4.0 / 3.1	65	325 x 265
 DGGL 5 perforated (GN 1/3)	For cooking vegetables, fish, meat and potatoes	2.5 / 2.0	65	325 x 175
 DGGL 6 perforated (GN 1/3)	For blanching or cooking vegetables	4.0 / 2.8	100	325 x 175
 DGG 7 solid (GN 1/3)	For cooking a medium sized quantity of soup or a medium sized casserole	4.0 / 2.8	100	325 x 175
 DGD	Lid for solid cooking containers DGG 2 and DGG 7	-	-	-

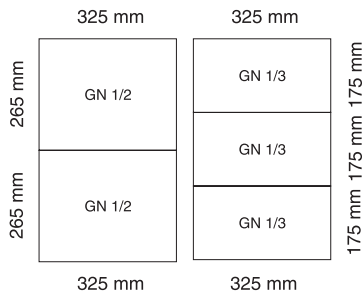

* Gastro-Norm sizes (Example GN 1/3)

1/3 or 1/2 is the width and depth of the cooking containers as shown below.

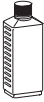

Guide to the appliance

Other accessories

Description	Use
 Miele descaling tablets (6 tablets)	For descaling Miele steam ovens and coffee machines
 Stainless steel conditioning agent 250 ml	Helps prevent re-soiling, water marks and finger prints on stainless steel surfaces
 Miele ceramic hob cleaner 250 ml	For removing discolouration on the floor heater caused by drops of liquid
Microfibre "E-Cloth" (Miele UK only)	For cleaning surfaces such as stainless steel, glass, plastic and chrome without the use of chemicals

Miele accessories are available from

- your Miele dealer or
- the Miele Spare Parts Department (see back cover for contact details)
- online at www.miele.co.uk.

Warning and Safety instructions

To avoid the risk of accidents and damage to the appliance, please read these instructions carefully before using it for the first time. They contain important notes on its installation, safety, use and maintenance. This appliance is not intended for use by persons (including children) with reduced physical, sensory or mental capabilities, or lack of experience or knowledge, unless they have been given supervision or instruction concerning the use of the appliance by a person responsible for their safety.

Please stick the extra data plate for your appliance supplied with this documentation in the space provided in the "After sales service" section of this booklet.

Keep these instructions in a safe place for reference, and pass them on to any future user.

■ This appliance may be connected via a fused plug and switched socket. If you wish to connect it to an isolator switch, or if the appliance is supplied without a plug, it must be installed and connected by a suitably qualified and competent person in strict accordance with current local and national safety regulations. The manufacturer cannot be held liable for damage caused by incorrect installation or connection.

■ The electrical safety of this appliance can only be guaranteed when continuity is complete between it and an effective earthing system which complies with current local and national safety regulations. It is most important that this basic safety requirement is present and regularly tested, and where there is any doubt, the household wiring system should be inspected by a qualified electrician. The manufacturer cannot be held liable for the consequences of an inadequate earthing system (e.g. electric shock).

■ Do not connect the appliance to the mains electricity supply by an extension lead. Extension leads do not guarantee the required safety of the appliance (e.g. danger of overheating).

■ Never open the casing of the appliance.
Tampering with electrical connections or components is highly dangerous to the user and can cause operational faults.

Technical safety

■ Before connecting the appliance to the mains supply make sure that the connection data on the data plate (voltage and connected load) match the mains electricity supply. This data must correspond in order to avoid the risk of damage to the appliance. Consult a qualified electrician if in any doubt.

Warning and Safety instructions

Correct use

■ For safety reasons, the appliance must only be used after it has been built in. This is necessary to ensure that all electrical components are shielded.

■ This appliance is intended for domestic use only and is not to be used for commercial purposes.

■ This appliance must only be used as described in these instructions. Any other usage is at the owner's risk and could be dangerous. The manufacturer cannot be held liable for damage resulting from incorrect or improper use or operation.

■ Do not immerse the water container in water, or clean it in a dishwasher. Connecting the water container into the appliance when wet could cause an electric shock.

■ For reasons of hygiene and to prevent the build-up of moisture in the appliance, the water container should be emptied after each use.

■ The drip channel should be wiped dry with a soft cloth after each use.

■ Leave the door open until the cooking compartment is completely dry.

■ If the appliance is not going to be used for a longer period of time, e.g. whilst on holiday, it should be thoroughly cleaned beforehand to prevent the build-up of odours etc. Refer to "Cleaning and heating up for the first time" and carry out the procedure as described. Leave the door open afterwards.

Warning and Safety instructions

Safety with children

■ To safeguard against burning, keep children away from the appliance at all times. This is particularly important when the appliance is in operation as children might try to open the door.

■ The appliance is only intended for use by adults who have read these instructions. It is not a toy! To avoid the risk of injury, keep children well away, and do not allow them to play with it or use the controls. They will not understand the potential dangers posed by it. They should be supervised whenever you are working in the kitchen.

■ Use the safety features to prevent children operating the appliance or altering the settings.

■ Warning: Take care in the area around the door hinges. Danger of injury. Keep children well away.

■ Do not allow children to lean against the open oven door, nor to sit on it or swing on it.

■ Packaging, e.g. cling film, polystyrene and plastic wrappings, must be kept out of the reach of babies and young children. Danger of suffocation. Dispose of or recycle all packaging safely as soon as possible.

■ Before discarding an old appliance, switch off and disconnect it from the power supply. Cut off and render any plug useless. Cut off the cable directly behind the appliance to prevent misuse. This should be done by a competent person. Ensure the appliance prevents no danger to children while being stored for disposal. See "Disposal of your old appliance" for further details.

Warning and Safety instructions

Protecting the appliance from damage

■ Do not use the appliance to heat up food in sealed jars and tins. Pressure will build up inside them and they can explode causing damage to the appliance, as well as the risk of injury and scalding.

■ Do not store cooked food in the oven. The moisture in the food can lead to corrosion in the appliance.

■ Do not use metallic containers or utensils in the oven which are likely to rust. This can cause corrosion.

■ Use the descaling tablets supplied with the appliance (see "Optional accessories" for reordering details) or a proprietary citric acid based descaling agent to descale the appliance. Follow the manufacturer's instructions on the packaging.

■ Do not use a steam cleaner to clean this appliance. The steam could reach electrical components and cause a short circuit. Pressurised steam could also cause permanent damage to the surface and to other components, for which the manufacturer cannot accept liability.

■ Do not place heavy objects on the open door. The door can support a maximum weight of 8 kg.

■ The appliance is designed in such a way that there will always be a little residual water left in the water container after use. If there is no residual water, there is something wrong. Call the Service Department.

Warning and Safety instructions

Protection from burning and scalding

■ For added protection, it is advisable to use heat-resistant pot holders or gloves when using the appliance. Do not let them get damp or wet, as this causes heat to transfer through the material more quickly with the risk of scalding or burning yourself.

■ When putting cooking containers or the condensate tray into the oven or taking them out, take care not to spill the contents. Avoid contact with hot steam, and do not touch the hot oven interior walls. Danger of burning and scalding.

■ Take care not to tip the water container when taking it out of the appliance. Hot water can scald.

Appliance faults

■ In there is any damage to the appliance, it must be switched off and disconnected from the mains supply immediately. It must not be used again until it has been repaired. If the appliance has not yet been fully installed, the electricity cable must be disconnected from the supply point. If connected via a plug and socket, switch off at the socket and withdraw the plug. Contact the Miele Service Department.

Do not reconnect the appliance to the mains electricity supply until after it has been repaired.

■ Repairs should only be carried out by a suitably qualified and trained person in accordance with local and national safety regulations. Repairs and other work by unqualified persons could be very dangerous and could damage the appliance. The manufacturer cannot be held liable for unauthorised work. Never open the housing of the appliance.

■ While the appliance is under guarantee, repairs should only be undertaken by a service technician authorised by the manufacturer. Otherwise the guarantee will be invalidated.

Warning and Safety instructions

Futher safety notes

■ When using an electric socket near the appliance, care should be taken that the cable of the appliance cannot get trapped by the appliance door. The insulation on the cable could become damaged, giving rise to an electric shock hazard.

■ Always ensure that food is sufficiently cooked or reheated. Some foods, e.g. poultry, may contain micro-organisms which are only destroyed by thorough cooking at a sufficiently high temperature for long enough. If in doubt, select a longer cooking or reheating time.

■ If using plastic cooking containers, make sure that they are heat- and steam-resistant to 100 °C. Otherwise they may melt, distort or break.

■ In countries where there are areas which may be subject to infestation by cockroaches or other vermin, pay particular attention to keeping the appliance and its surroundings in a clean condition at all times. Any damage caused by cockroaches or other vermin will not be covered by the guarantee.

The manufacturer cannot be held liable for damage caused by non-compliance with these Warning and Safety instructions.

Disposal of the packing material

The transport and protective packing has been selected from materials which are environmentally friendly for disposal and can normally be recycled.

Packaging, e.g. cling film, polystyrene and plastic wrappings, must be kept out of the reach of babies and young children. Danger of suffocation.

Dispose of or recycle all packaging materials safely as soon as possible.

Disposal of your old appliance

Electrical and electronic appliances often contain materials which, if handled or disposed of incorrectly, could be potentially hazardous to human health and to the environment. They are, however, essential for the correct functioning of your appliance. Please do not therefore dispose of your old appliance with your household waste.

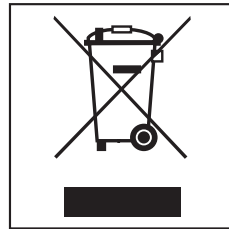

Please dispose of it at your local community waste collection / recycling centre and ensure that it presents no danger to children while being stored for disposal.

It should be unplugged or disconnected from the mains electricity supply by a competent person. If connected by a plug, the plug must be rendered useless and the cable cut off directly behind the appliance to prevent misuse.

Using for the first time

The steam oven is supplied with the controls pushed in. They have to be released before the steam oven can be used.

When the steam oven is first connected to the mains supply it will switch on automatically and a welcome message will appear in the display.



The display will then change to show the language settings menu.

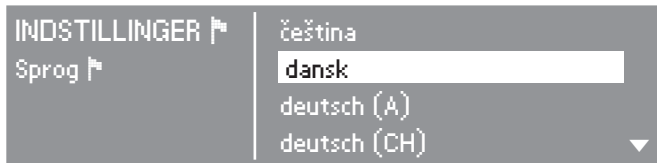

- Turn the multi-function selector clockwise until the language you want is highlighted in the display.
- Press the multi-function selector gently to confirm your selection.

After selecting the language you will be prompted to set the time of day. If this prompt does not appear, proceed as described in "Changing the time of day".

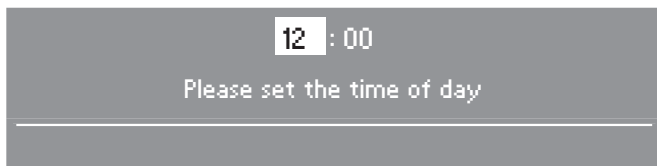

When the steam oven is first switched on, the clock will show 12:00 until you have set the correct time.

The factory default setting for the clock is 24 h.

Using for the first time

- Turn the multi-function selector clockwise until the required hour is shown in the display. Then press it gently to confirm your selection.

After setting the hour, the minutes will be highlighted.

- Turn the multi-function selector clockwise until the required minutes are shown in the display. Then press it gently to confirm your selection.

You will then be prompted whether to have the time showing in the display or not. If this prompt does not appear, proceed as described in "Changing settings - Display".



If you select "Off" the display will go dark in 60 seconds. The time of day continues to run unseen in the background. It will reappear for 60 seconds if you press the On/Off switch or the multi-function selector gently.

If you select "On" it will remain in the display all the time.

Because this oven is pre-equipped for the Miele@home system the following message will appear briefly in the display:

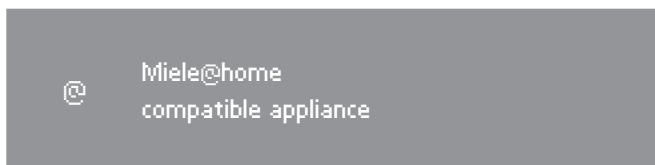

The current time of day will then reappear in the display and your steam oven is now ready to use.



Using for the first time

Setting the water hardness

The steam oven is set at the factory to water hardness setting IV (Very hard 4).

If your water hardness level differs from this you will need to re-programme the appliance.

You can use the test strip supplied to check the water hardness level, or your local water supplier will be able to advise you on the water hardness of your area.

The water hardness is shown as settings I to IV equivalent to the German scale 1 to >21 °dH (0.2 >3.8 mmol/l).

Hardness setting	Display	Hardness level
I	Soft 1	1-7 °dH (0.2-1.3 mmol/l)
II	Medium 2	8-14 °dH (1.4-2.5 mmol/l)
III	Hard 3	15-21 °dH (2.7-3.8 mmol/l)
IV	Very hard 4	>21 °dH (above 3.8 mmol/l)

Using for the first time

- Switch the appliance on by pressing in the On/Off switch gently.
- Turn the multi-function selector anti-clockwise to "Settings".



- Confirm your selection by gently pressing the multi-function selector.



- Turn the multi-function selector clockwise until "Water hardness" is highlighted in the display.
- Confirm your selection by gently pressing the multi-function selector.

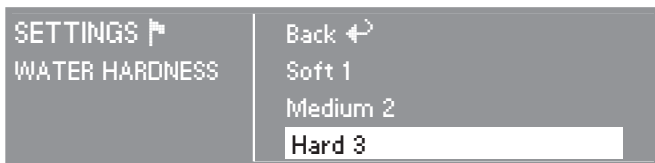

- Turn the multi-function selector clockwise until the water hardness setting you want, e.g. Hard 3, is highlighted in the display.
- Confirm your selection by gently pressing the multi-function selector.
- Now turn the multi-function selector anti-clockwise to "Back", confirm this selection and switch the appliance off by pressing the On/Off switch (on the left).

Using for the first time

Cleaning and heating up for the first time

Take the water container out of the appliance and remove the insert (see "Cleaning and care"). Rinse the water container and the insert thoroughly by hand using hot water. Do not use any washing-up liquid or detergent.

Do not clean the water container or the insert in a dishwasher. Do not immerse the water container in water.

Take all accessories out of the steam oven and wash them in a mild solution of washing-up liquid and hot water or in the dishwasher (this does not apply to the water container and insert - see above).

The interior of the steam oven has been treated with a conditioning agent before leaving the factory. To remove this, clean the cooking compartment with a mild solution of washing up liquid and hot water and then dry thoroughly with a soft cloth.

Now fill the water container with mains tap water (see "Before each use") and then run the Cook Universal (100 °C) for 15 minutes. Proceed as described in "Operation".

This process flushes out the waterways and sets the appliance for the altitude in your area.

If you **move house**, the appliance will need to be re-set for the new altitude if this differs from the old one by more than 300 m. To do this, descale the appliance (see "Cleaning and care").

Warning! A lot of steam will be emitted from the appliance the first time it is used, and the first time it is descaled after moving house.

Controls

The steam oven is supplied with the controls pushed in. They have to be released before the steam oven can be used.

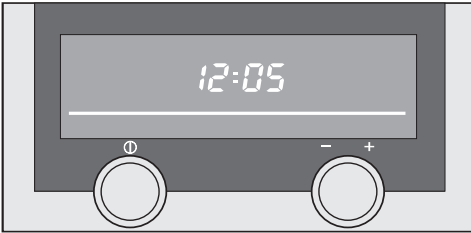

The **On/Off switch** on the left can only be pressed. It does not rotate. Pressing it lightly switches the steam oven on or off. A stronger press will release the switch or push it back in again.

The **multi-function selector** on the right can be pressed and rotated. Turning it selects a function which you either want to use or change settings for. The functions available are highlighted in the display as you turn the selector.

A light press on the selector confirms your selection. A stronger press will release the switch or push it back in again.

Night dimming

Between the hours of 22:00 and 6:00 the lighting in the display is dimmed automatically.

If you have chosen for the time of day to be displayed, this will also be dimmer.

If the appliance is switched on during this period, the display will brighten again.

Operation

Operating sequence

- Press and release the controls.
- Switch the appliance on by pressing in the On/Off switch gently.

The **Main menu** will appear in the display.

COOK UNIVERSAL	ALL FUNCTIONS...
COOK FISH	AUTOMATIC...
COOK VEGETABLES	USER PROGRAMMES...
COOK MEAT	SETTINGS ↵...

Four functions will appear in the left-hand column. They can be selected directly.

Alternatively, you can change this list via the Settings menu to suit your particular preferences. (See "Changing settings - Main menu").

Further functions can be called up via the All functions menu. The following are available: Cook Universal, Cook Fish, Cook Vegetables, Cook Meat, Reheat, Defrost, Descal.

Menus which have further sub-menus are displayed in the right-hand column.

- Turn the multi-function selector clockwise until the menu option you want is highlighted in the display.
- Press the multi-function selector gently to confirm your selection.

This calls up the menu option.

When a function is selected, e.g. Cook Vegetables, the following appears in the display:

COOK VEGETABLES	100 °C	12:15
		
Time	Duration	Save

When a menu is selected, e.g. Settings, further sub-menus appear which can be called up and changed.

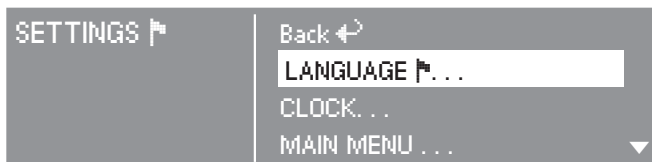

The triangle symbols at the top and bottom of the display indicate that you can scroll to further options by turning the multi-function selector.

- Turn the multi-function selector clockwise until the menu option you want, e.g. Language, is highlighted in the display.
- Press the multi-function selector gently to confirm your selection.

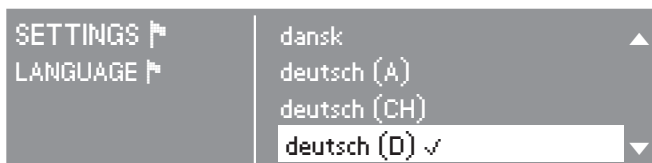

This takes you to the next sub-menu and you can now highlight the setting you want and confirm your selection.

A tick will appear next to the setting currently selected. In this example: deutsch (D).

To return to the previous menu, select "Back" and press the multi-function selector to confirm your selection.

Please note:

Information next to the **i** symbol will go out after a few seconds. You can turn it off by pressing the multi-function selector.

The functions, menus and how to set them are described in more detail on the following pages.

Operation

Changing the time of day

In the following example the time of day is changed from 10:15 to 12:17.

The steam oven is switched off.

- Turn the multi-function selector clockwise until "Clock" is highlighted in the display.



- Press the multi-function selector gently to confirm your selection.



The number **10** will be highlighted.

- Turn the multi-function selector until **12** is displayed and then press the selector gently.

After setting the hour, the minutes will be highlighted.

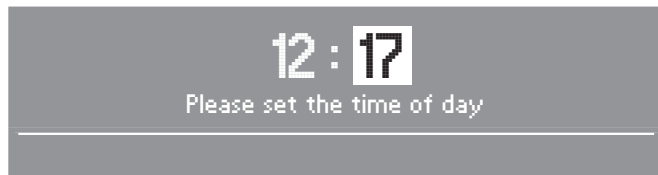

- Turn the multi-function selector until **17** is highlighted and then press the selector gently.

This confirms the minutes.

The current time of day will reappear even after a power cut. The steam oven stores this information for approx. 200 hours. After that "12:00" will flash in the display as it did when first switched on. You will have to re-set the time if this happens.

Minute minder

The minute minder can be used to time any activity in the kitchen, e.g. boiling eggs.

When cooking whole meals you can also use the minute minder to remind you when to place the next dish in the steam oven.

A duration of between 10 seconds (0:10 min) and 12 hours (12:00 h) can be set.

With a minute minder time of between 10 seconds and 2 minutes, the time is set in 10 second stages.

With a minute minder time of between 2 minutes and 10 minutes, the time is set in 30 second stages, e.g. 1 minute 30 seconds = 1:30 min.

With a minute minder time of between 11 minutes and 12 hours, the time is set in 1 minute stages, e.g. 90 minutes = 1:30 h.

- Turn the multi-function selector clockwise until "Time" is highlighted in the display.



- Press the multi-function selector to confirm your selection.

0:00 min will appear in the display.

Operation



- Turn the multi-function selector until the minute minder time you want appears and confirm your selection.

You will then see the minute minder time counting down in the display.

At the end of the set time you will hear a buzzer. You can turn it off by pressing the multi-function selector.

Cancelling the minute minder

Call up the Minute minder option and set the time to *0:00*.

Recommended temperature

The following recommended temperatures are set at the factory:

Function	Recommended temperature in °C / °F	Temperature range which can be set in °C / °F
COOK UNIVERSAL	100 / 210	40 - 100 / 105 - 210
COOK FISH	85* / 185*	75 - 100 / 165 - 210
COOK VEGETABLES	100 / 210	90 - 100 / 195 - 210
COOK MEAT	100 / 210	90 - 100 / 195 - 210
REHEAT	100 / 210	80 - 100 / 175 - 210
DEFROST	60 / 140	50 - 60 / 120 - 140

* Increase the recommended temperature to 100 °C or 210 °F when cooking fish with liquid in a solid container.

You can change the recommended temperatures within the ranges given just once or permanently.

Please refer to the instructions given in "Changing settings - Temperatures" if you want to change the settings permanently to suit your particular preferences.

Operation

Before each use

- When using a perforated cooking container, push the condensate tray onto the lowest shelf runner to catch any drips.
- Fill the water container.

You do not need to remove the insert.

Only use **mains tap water**. Never use distilled or mineral water.

The water level must be between the two markings (min. 0.75 l and max. 1.2 l). These are located inside and outside the container. On no account exceed the upper or maximum level marker. The amount of water required will vary depending on what you are cooking.

The maximum quantity of 1.2 litres of water is sufficient to run the Cook Universal 100 °C function for approx. 2 hours, providing the door is not opened. The water level in the water container is represented by a symbol in the display.

Using hot water will shorten the heating-up time.

- Always use both hands when carrying the water container, and push it into the appliance until it connects. Take care not to let any water spill out.

Selecting a steam oven function

- Press and release the controls.
- Switch the appliance on by pressing in the On/Off switch gently.

The main menu will appear.



- Turn the multi-function selector clockwise until the function you want, e.g. Cook Vegetables, is highlighted in the display.



- Press the function selector to confirm your selection.

Selecting a temperature

After you have confirmed the selection of the function, the recommended temperature will appear highlighted in the display.



- Press the function selector to confirm the selection of the recommended temperature.

If you do not want to use the recommended temperature, turn the multi-function selector to set a different temperature. Confirm your selection by pressing the function selector.

Operation

Setting a cooking duration

After you have confirmed the (recommended) temperature, the display will change to show the screen for setting the cooking duration (Duration).

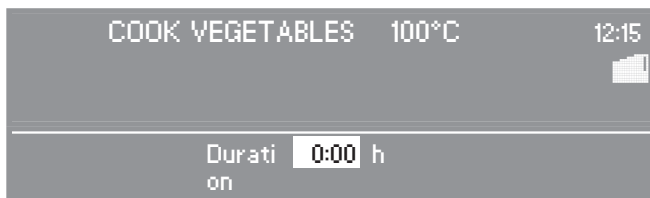

- Use the multi-function selector to set the duration, e.g. 10 minutes (0:10 h).

The duration is shown in hours (h). If you do not set the duration within a few seconds, the display will change to show the previous setting.

A duration of between 1 minute (0:01 h) and 6 hours (6:00 h) can be set.

- Press the function selector to confirm the selection of the duration you have set.

The charts later in this booklet and the cookery book give suggested cooking durations for various types of food. Remember that the cooking duration is not dependent on the amount of food, but on the size of the food. For example, large potatoes will take longer to cook than smaller potatoes.

To achieve good results using the durations quoted, please do not cook quantities of food for more than 8-10 servings. Cooking durations will also vary depending on the cooking container used (see "Suitable containers").

Starting a programme

The appliance is set up at the factory so that it starts **automatically** as soon as you have confirmed the cooking duration.

If you prefer to always start the programme **manually**, you will have to alter the standard setting for Start to "manual" (see "Changing settings - Start").

After the start, you will hear the noise of the fan and the heating-up phase will begin.

You can follow the rise in temperature in the oven compartment in the display.

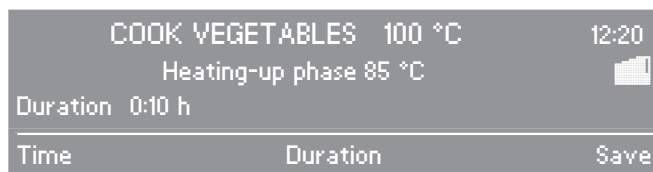

As soon as the set temperature has been reached, "Heating-up phase" will disappear. The cooking phase will now begin and the duration will start counting down.



Please note that when preparing food which has been refrigerated or frozen, the temperature in the cooking compartment will fall initially before starting to rise gradually.

The total duration, i.e. the time between the beginning and end of a function, is made up of the heating-up time and the set cooking duration added together. The heating-up time depends on the quantity and initial temperature of the food, and does not need to be added to the duration.

Operation

Saving settings

You can save the settings for a cooking programme while it is in progress, so that you can call it up again from the User Programmes menu at a later date.

- Select "Save" and confirm your selection.

Follow the instructions given in "User programmes - Save".

Interrupting a programme

You can interrupt a programme at any time by opening the door.

The heating will be switched off and the cooking duration remaining stored in memory.

Steam will escape when the door is opened. Step back from the steam oven and wait until the steam has dissipated.

When putting cooking containers or the condensate tray into the oven or taking them out, take care not to spill the contents. Avoid contact with hot steam, and do not touch the hot oven interior walls. Danger of burning and scalding.

To continue the programme, close the door.

When the door is closed, the pressure has to equalise, which can cause a whistling sound.

The appliance will heat up again. Once the set temperature has been reached, the display will change to show the cooking duration remaining as it counts down.

Changing the settings during operation

Changing the function

- Turn the multi-function selector until the function you are using is highlighted and then press the selector gently.

The display will change.

- Select the function you want and proceed as before.

Changing the temperature

- Turn the multi-function selector until the temperature you have already selected is highlighted and then press the selector gently.
- Select the temperature you want, e.g. 80°C, and confirm your selection.

Altering the duration

- Turn the multi-function selector until the "Duration" in the bottom line of the display is highlighted and confirm this selection.
- Turn the multi-function selector until the "Duration" in the next line up of the display is highlighted and confirm this selection.
- Select the duration you want you want and confirm your selection.

Operation

At the end of the cooking duration

The last minute of the cooking duration is shown in minutes rather than hours. The display will change from hours (0:02 h) to minutes (1:00 min).

Shortly before the end of the set cooking duration, the steam will be reduced and the door will open slightly.

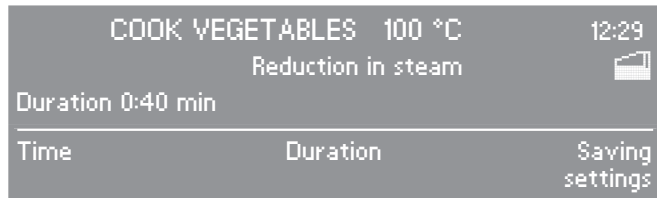

At the end of the duration you will hear a buzzer. The door will start to close shortly afterwards.

Wait until "Programme finished" appears in the display before opening the door and removing the food.



The steam oven is set at the factory so that if it is not switched off at the end of a cooking programme, it will maintain a temperature of 70 °C for a maximum of 15 minutes to keep food warm. Please note that delicate food, especially fish, can continue cooking whilst being kept warm.



If you do not want to use this function, you will need to change the factory default setting (see "Changing settings - Keeping warm").

When putting cooking containers or the condensate tray into the steam oven or taking them out, take care not to spill the contents. Avoid contact with hot steam, and do not touch the hot oven interior walls. Danger of burning and scalding.

After use

- Switch off the appliance.
- Remove the condensate tray and empty it.
- Remove the water container and empty it.
- After each use, clean and dry the whole appliance as described in "Cleaning and care".
- Leave the door open until the cooking compartment is completely dry.

The fan will continue to run for a while after the oven has been switched off. If you want to reduce the run-on time, you can do so by removing the water container as soon as you have switched the appliance off.

The appliance is designed in such a way that there will always be a little residual water left in the water container after use. If there is no residual water, there is something wrong. Call the Service Department.

Operation

Automatic

You can choose from an extensive range of automatic programmes: Cook Vegetables, Cook Fish, Cook Shellfish, Cook Mussels, Cook Meat, Cook Pulses, Cook Side dishes, Cook Grain, Cook Fruit, Cook Eggs, Reheat, Defrost and Bottling. Cooking temperature and duration are pre-set, so you only need to select the category and confirm your selection.

Automatic programmes Cook Vegetables and Cook Fruit have a medium cooking level set as standard. You can select from "al dente" to "Soft" by turning the multi-function selector.

Example:

You want to prepare a side dish of floury boiled potatoes cut up into small pieces.



- Select and then confirm the following:

- "Automatic..."
- "Cook Side dishes..."
- "Potatoes..."
- "Boiled potatoes..."
- "Floury..."
- "Chopped up..."
- "Dice"

The steam oven starts automatically.



User programmes

You can give programmes you use frequently their own individual names and then save them in the User Programmes menu. You can save up to 30 different user programmes.



You can also enter these programmes into the main menu.

Compile

- Select and confirm "User Programmes".

If you have not yet created any user programmes only the word "Compile" will appear in the display.

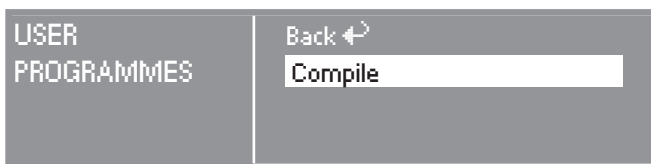

- Select and confirm "Compile".
- Select and confirm the function, e.g. Cook Fish, the recommended temperature and duration.



- Check the settings and confirm them with OK.

Operation

Save



- Select and confirm "Save".



- Select and confirm the individual letters or numbers. The symbol after the Z is for a space.

Your name will start to appear next to "Save as" as you enter the letters. If you make a mistake you can use "Delete" to delete the last letter or number you entered.



- Check the settings and confirm them with OK.

You can now call up your cooking programme from the User Programme menu under the name you have chosen.

You can also display/alter and delete your own user programmes in the User Programmes menu.

If you select "Start" instead of "Save", the cooking programme will begin. You can then give the programme a name via "Save" as already described.



Delay start

You can delay the start of a cooking programme. The steam oven will then switch on and off automatically. It is only possible to delay the start within 90 seconds after making an entry.

- Select the function, temperature and duration in the normal way.



- Select and confirm "Duration".

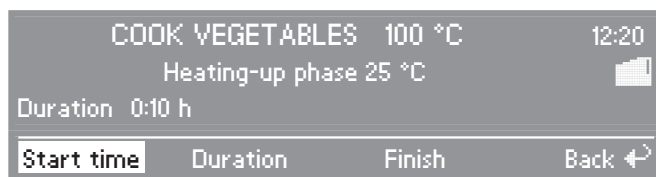

The following options will then appear in the display: Start time, Duration, Finish.

Use:

- Duration to set the cooking duration as normal.
- Start time to specify the time you want cooking to start.
- Finish to specify the time you want cooking to end.

You can delay the start by entering **either** the Start time **or** the Finish time. Please note that the difference between the Start time and Finish time is the cooking duration selected plus the heating-up time which the steam oven calculates.

This function cannot be used if the cooking compartment is still too hot at the end of a cooking programme.

Safety features

Lock (LOCK)

The lock prevents the steam oven being switched on unintentionally, by children for example.

The appliance is delivered with the lock switched off (factory default setting). Before this feature can be activated, you will need to alter the factory default setting (this only needs to be done once).

To alter the factory setting

- Call up the "Settings - Safety" menu.

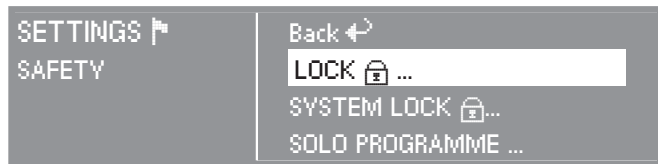

- Confirm "Lock .
- Confirm "permitted".

Now that the setting has been altered, the  will appear in the display when the appliance is switched off.

To activate the lock

- Select and confirm the  symbol.
- Now confirm "On".



The  symbol will appear in the display. Now the appliance cannot be switched on. The minute minder can still be used whilst the lock is on. The lock remains active even after a power cut.

To deactivate the lock

- Select and confirm the  symbol.
- Select and confirm "Off".

System lock (SYSTEM LOCK)

The system lock prevents the settings being altered when the appliance is operating.

The appliance is delivered with the system lock switched off (factory default setting). Before this feature can be activated, you will need to alter the factory default setting (this only needs to be done once).

To alter the factory setting

- Call up the "Settings - Safety" menu.

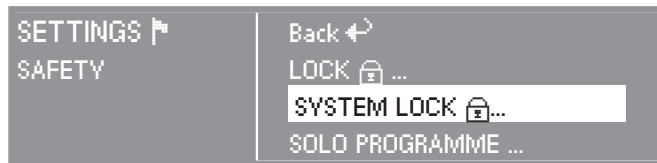



- Select and confirm "System lock .
- Confirm "permitted".

Now that the setting has been altered, the  will appear in the display when a function is selected.

To activate the system lock

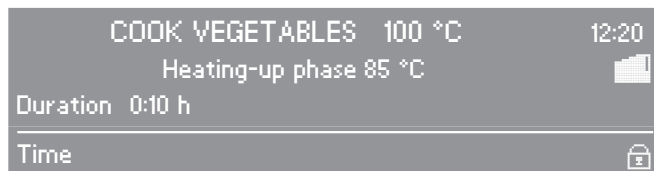
- Select the function, temperature and duration in the normal way.
- Select and confirm the  symbol.
- Now confirm "On".



The  symbol will appear in the display. Now the settings cannot be altered. The minute minder can still be used whilst the system lock is on.

Safety features

To deactivate the system lock

- Select and confirm the  symbol.
- Select and confirm "Off".

The system lock will remain activated at the end of a locked cooking programme or if a locked programme is cancelled. You will need to deactivate the system lock before you can start another programme.

Solo Programme

When Solo Programme is activated, a programme you have pre-selected will be started automatically.

Before this feature can be activated, you must first alter the factory setting "Safety - Lock" to "permitted" and also set up the cooking programme.

To set up a Solo Programme

- Call up the "Settings - Safety" menu.
- Alter the "Lock 

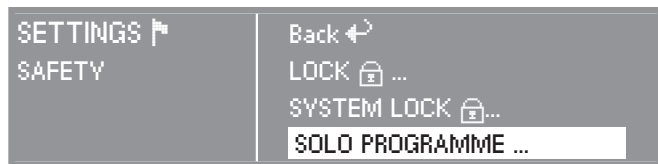

- Select and confirm "Solo Programme".



- Select and confirm "Function".
- Specify the function, temperature and duration and confirm with OK.

You can also choose one of your user programmes as the Solo Programme.

Now that the setting has been altered, the  will appear in the display when the appliance is switched off.

To activate the Solo programme

- Select and confirm the  symbol.
- Select and confirm "Solo".



 / SOLO will appear in the display. This programme will now start when the appliance is switched on. The settings cannot be altered. The appliance can only be switched off.

To deactivate the Solo Programme

- Select and confirm  / SOLO.
- Select and confirm "Off".

Changing settings

Some of the standard steam oven settings (factory default settings) have an alternative which you can select if required. You can alter several settings one after the other.

Proceed as follows:

- Switch on the steam oven.
- Select and confirm the Settings menu.

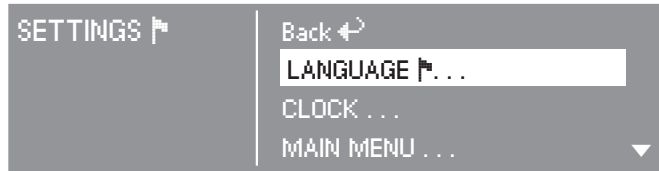

- Select and confirm the Setting you wish to alter.

Currently selected settings are indicated by a tick ✓ next to them.

If you do not make a selection in the sub-menu within approx. 5 seconds, the display will revert to the Settings menu.

Language 🇵🇸

You can set the display to show the language of your choice.

You do this via the Languages 🇵🇸 sub-menu.

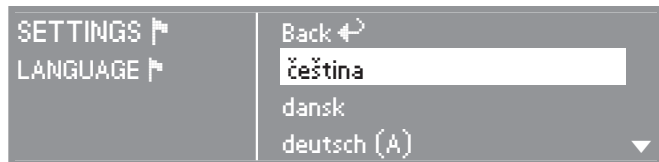

- Select and confirm the language you want.

The language you have selected will appear in the display.

If you have selected the wrong language by mistake you can follow the flag symbol 🇵🇸 to get yourself back to the LANGUAGE sub-menu.

Clock

You can select either a 24 hour or 12 hour clock. Select and confirm the one you want.

Main menu

The four cooking functions listed in the left-hand side of the display can be changed to show ones that you use frequently or to show your user defined programmes.

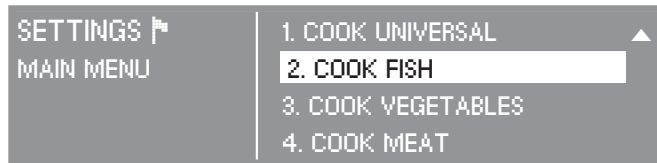

- Select and confirm the one you want to change.



- Then select a new cooking function or one of your own programmes and confirm it.

Start

Depending on the setting, the cooking programme will start automatically about 20 seconds after the last entry was made. Alternatively you can start it manually.

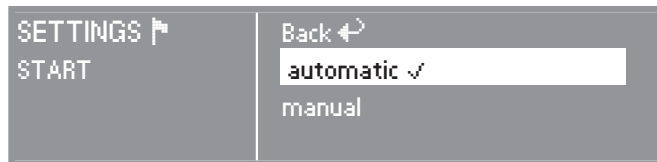

- Select and confirm the setting you want.

If you have set it for manual start, the "Start" option will be highlighted before the beginning of the programme. To start the programme you have to press the multi-function selector. Once "Start" is confirmed, "Stop" will appear in the display. You can interrupt the programme by selecting and confirming "Stop".

Changing settings

Keeping warm

The steam oven is set at the factory so that if it is not switched off at the end of a cooking programme, it will maintain a temperature of 70 °C for a maximum of 15 minutes to keep food warm. Please note that delicate food, especially fish, can continue cooking whilst being kept warm.

If you do not want to use this feature, select and confirm the "Off" option.

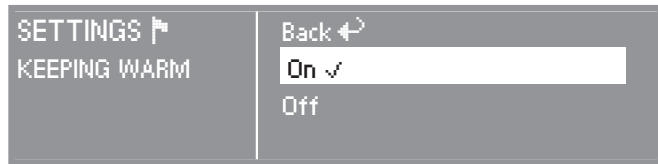

Temperatures

If you frequently change a recommended temperature it may be a good idea to change it permanently.

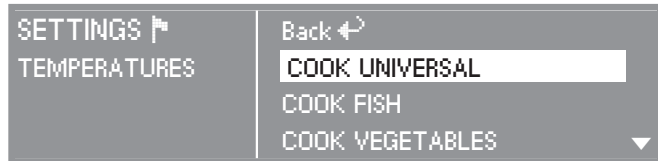

- Select and confirm the function you want and then change the temperature and confirm it.

Water hardness

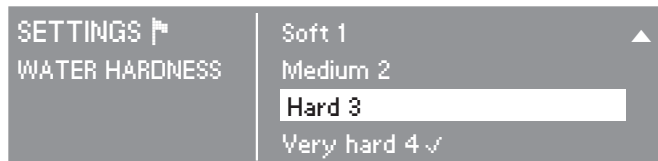

- Select and confirm the setting you want.

Display

Depending on setting, the display will be on all the time or will only be visible for a short time.

If the "On for 60 seconds" option is selected, the display will go dark after 60 seconds. The time of day continues to run unseen in the background.

If "On" is selected, it will remain in the display all the time.

The contrast and brightness can also be adjusted.



- Select and confirm the setting you want.

Buzzer tones

The volume, melody and tone length can all be altered.

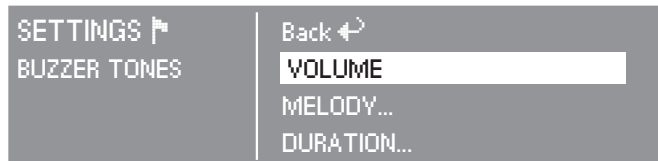

- Select and confirm the setting you want.

Safety

- Please see chapter "Safety features".

Units

Temperatures can be displayed in °C or °F, and weights in kg or lbs.

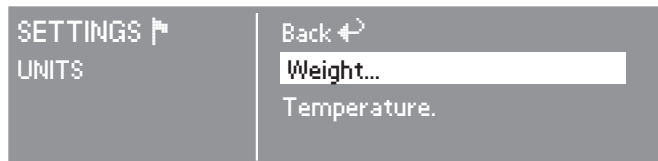

- Select and confirm the setting you want.

Changing settings

Demo mode



Demo mode is for dealers who want to demonstrate the appliance without the heater elements working. Do not activate this setting for domestic use!

After a short while the message will go out and the Demo mode can be switched on or off.

Factory default



- Select and confirm the setting you want.

ALL SETTINGS: Any setting that you have altered will be reset to the factory default setting. User defined programmes will be deleted.

USER PROGRAMMES: User defined programmes will be deleted.

MAIN MENU: The main menu will be reset to the factory default setting.

TEMPERATURES: Any alterations to recommended temperatures will be reset to the factory default settings.

Suitable containers

Some stainless steel cooking containers are supplied with the appliance. Other containers, in a variety of sizes, both perforated and solid, are available as optional extras.

When choosing the most suitable container for the particular food you are cooking, please note:

- Use perforated cooking containers whenever possible, e.g. for vegetables. The steam can reach the food from all sides and the food is cooked evenly.
- With large items of food, such as whole potatoes, the steam can work effectively because there are spaces between the individual pieces into which the steam can penetrate. This way a large quantity will take the same time to cook as a smaller amount and large, deep containers can be used. Where possible, space the food out to allow the steam more room.
- More compact dishes such as casseroles or bakes, or food such as peas or asparagus spears, which have little or no space between them, will take longer to cook because the steam has less space to work in. The fuller the container, the longer it will take to cook. It is best to use 2 or 3 shallow containers rather than one deep one for these types of foods, and then fill them only 3-5 cm deep. Cooking durations quoted are calculated on this principle. Deeper dishes will take longer to cook.

You will find various tips on how to use the steam oven in the following sections or in the cook book.

Heat-resistant glass, ceramic, porcelain, stainless steel and enamel dishes are all suitable. Important:

- If using plastic cooking containers, make sure that they are heat-resistant to 100 °C and able to withstand hot steam.
- Food will take considerably longer to cook than the time quoted if the dish has thick sides.
- Place the container on the rack supplied.
- Ensure that there is a gap of at least 3 cm between the upper rim of the container and the top of the cooking compartment to allow sufficient steam into the container.

Practical tips

Steaming

Food	Function	Temperature in °C	Duration in minutes	
			al dente	well done
Vegetables				
Asparagus, green	COOK VEG	100	3-5	6-8
Baby Carrots (whole)	"	100	3-5	6-9
Beans (french)	"	100	3	4-5
Beans (runner, sliced)	"	100	2-3	4-5
Beetroot (whole)	"	100	-	20-30
Broccoli	"	100	4	5-7
Brussels sprouts	"	100	4-6	8-10
Cabbage (shredded)	"	100	4-6	8-10
Carrots (stick)	"	100	1-2	3-4
Cauliflower (florets)	"	100	2-3	5-7
Courgettes (sliced)	"	100	2	3
Fennel (quartered)	"	100	6-8	10-14
Leeks (sliced)	"	100	-	2-3
Mangetout	"	100	2	4
Mushrooms (whole)	"	100	-	3-4
Parsnips (halved)	"	100	2-4	6-8
Peas	"	100	2	4
Peppers (strips)	"	100	2-3	4-5
Potatoes (halved)	"	100	5-6	14-20
Potatoes, new (baby whole)	"	100	-	14-18
Spinach (fresh)	"	100	-	3-4
Sugar snap peas	"	100	2-3	4-5
Swede (diced)	"	100	1	4-6
Sweet potato	"	100	1	4-6
Sweetcorn (baby, whole)	"	100	2	6-8
Sweetcorn (whole cob)	"	100	8-10	20-24

You will find times quoted in the Automatic menu differ from those above.

Practical tips

Food	Function	Temperature in °C	Duration in minutes
Meat			
Beef goulash	COOK MEAT	100	40-50
Chicken breast	"	100	8-10
Chicken, whole	"	100	50-60
Knuckle of pork	"	100	90-95
Lamb ragout	"	100	12-16
Turkey escalope	"	100	4-6
Turkey roulade	"	100	12-15
Veal escalope	"	100	3-4
Fish (fresh)			
Cod steaks	COOK UNIVERSAL	100	5-6
Salmon (fillets)	"	100	6-8
Trout (fillets)	"	100	3-6
Tuna steak	"	100	6-8
Mussels	COOK FISH	90*	10-12
Plaice, fillet	"	85	5-7
Monk fish	"	85	8-10
Trout, 250 g	"	90*	10-12
Miscellaneous			
Blanching vegetables	COOK VEG	90*	1-2
Disinfecting baby bottles	COOK UNIVERSAL	100	15
Melting chocolate (use a cover)	COOK VEG	90*	4-10

* This temperature is not the same as the recommended temperature.

You will find times quoted in the Automatic menu differ from those above.

Practical tips

Food	Function	Temperature in °C	Duration in minutes
Dried beans and pulses			
Red kidney beans (pre-soaked)	COOK UNIVERSAL	100	60-65
Chick peas	"	100	50-60
Millet	"	100	9-10
Pearl Barley	"	100	60-80
Buckwheat	"	100	20-24
Red split lentils (un-soaked)	"	100	10-15
Yellow split lentils (pre-soaked)	"	100	40
Rice			
White basmati	COOK UNIVERSAL	100	8-10
Brown basmati	"	100	15-20
Long grain	"	100	10-12
Brown	"	100	12-16
Wild	"	100	50-60
Thai fragrant / Jasmine	"	100	10-12
Risotto / Arborio	"	100	16-20
Mixed basmati and wild rice	"	100	20
Eggs			
Soft boiled	COOK UNIVERSAL	100	3-4
Medium boiled	"	100	5-6
Hard boiled	"	100	8-10
Fruit			
Cooking apples (sliced)	COOK UNIVERSAL	100	1-2
Apples (sauce)	"	100	4-6
Peaches (halved)	"	100	4-6

You will find times quoted in the Automatic menu differ from those above.

Tips on steaming

- In general, the cooking durations for cooking with steam are the same as for cooking food in a saucepan.
- Steam prevents food from drying out so it remains moist, and juices are not lost. This applies to a wide variety of food, including dumplings, steam puddings, fish and meat dishes, as well as vegetables.
- You can select any shelf level. You can also cook on several levels at the same time. This will not alter the cooking duration.
- Food does not brown or get crisp from over-cooking. It is gently steamed, and not roasted or baked. Cheese melts perfectly without getting burnt. It is a healthy way of cooking, and it brings out the distinct flavour of the food.
- When cooking frozen food, e.g. vegetables, ensure that any large clumps frozen together are broken up first so that they cook evenly. The cooking duration is approximately the same as for fresh vegetables.
- Frozen and fresh vegetables which take the same length of time to cook can be cooked together.
- Frozen fish should be partially defrosted before cooking. We recommend using the "Defrost" function (see "Defrosting" for more information).
- Cooking with steam retains the true taste of the food better than conventional cooking. Therefore food should not be seasoned until after it has been cooked.
- Only fill solid containers $\frac{3}{4}$ full with liquid.
- Dried foods like pasta and rice must be cooked in liquid. Pasta should be well covered with liquid. With pulses, grains, parboiled rice, basmati rice and wild rice, the proportion of food to liquid should be 1:1, with brown rice 1:1.5 and risotto rice 1:2.
- When cooking noodles, follow the manufacturer's instructions on the packaging regarding cooking duration.
- Cooking liquids do not boil away. They are either absorbed by the food, as with rice and pasta, or they remain in the dish to form a sauce, as with casseroles. The sauce can then be thickened or added to after cooking.
- You can thicken sauces in the steam oven by adding flour and butter to liquid (40 g flour and 40 g butter to 0.5 litres liquid).

Practical tips

- Grease perforated containers beforehand if using them to cook fish, and solid containers if using to cook dishes containing eggs.
- When cooking fish or food with a distinctive colour (e.g. spinach) in a perforated container, place the container directly above the condensate tray to avoid any transfer of tastes or colour to other food.
- Yeast dough can be put in the oven to prove.
Select Cook Universal and reduce the recommended temperature to 40 °C. Cover the dough.
- The weight entry in the Automatic programmes refers to the weight per piece. The setting and therefore the cooking duration is the same whether cooking only one 250 g piece of salmon or ten 250 g pieces at the same time.

Reheating

REHEAT function	
Food to be reheated	Duration in minutes
Vegetables	
Cauliflower, runner beans, kohlrabi, carrots	2
Side dishes	
Dumplings, potatoes (halved)	3-4
Pasta, rice	2-3
Meat and poultry	
Sliced meat 1.5 cm thick	3-5
Stew	3-5
Chicken schnitzel	3-5
Meatballs in sauce	3-5
Sliced roulade	3-5
Fish	
Fish fillet	2-3
Fish roulade, halved	2-3
Plated meals	
Chicken fricassee with rice	3-5
Roast pork with potatoes and vegetables	3-4
Spaghetti with tomato sauce	2-3
Soups/casseroles	
Casseroles	4-5
Soup	2-3

You will find some more suggestions in the Automatic menu.

Your steam oven is very effective at reheating dishes which have been prepared previously.

Proceed as follows:

- Place the food on a flat plate and cover it with a deeper plate or some heat-resistant foil.
- Select and confirm the Reheat function.
- Select the duration (see chart) and confirm your selection.

Tip:

If sauces are to be served separately, reheat them in a covered dish on their own.

Practical tips

Defrosting

DEFROST function				
Food to be defrosted	Weight in g	Temp. in °C	Defrosting time in minutes	Standing time in minutes
Meat				
Stew	500	60	30-40	10-15
Minced meat	250	50*	15-20	10-15
Cutlets, chops, sausages	800	60	25-35	15-20
Poultry				
Chicken	1000	60	40	15-20
Chicken drumsticks	150	60	20-25	10-15
Chicken schnitzel	500	60	25-30	10-15
Fish, seafood				
Fish fillets	400	60	15	10-15
Prawns	300	60	4-6	5
Vegetables				
Frozen in a block	300	60	20-25	10-15
Frozen in small portions	350	60	15	8-10
Fruit				
Apple sauce/stewed apples	250	60	20-25	10-15
Berries	300	60	8-10	10-12
Dairy products				
Cheese	100	60	15	10-15
Cream	250	60	20-25	10-15
Baking				
Puff pastries	-	60	10-12	10-15
Yeast buns	-	60	10-12	10-15
COOK UNIVERSAL function				
Bread	250	100	10-15	10-15
Bread rolls	-	100	6-7	1-2

* This temperature is not the same as the recommended temperature.

Frozen food can be defrosted in this appliance in much less time than when defrosting at room temperature.

Proceed as follows:

- Place the food in a suitable container or on the rack.
- Select and confirm the Defrost function.
- Change the recommended temperature if necessary (see chart) and confirm your selection.
- Select the defrost time (see chart) and start the programme.

Tips on defrosting

- All meat and poultry should be fully defrosted before cooking. When defrosting meat or poultry place the condensate tray underneath the rack to catch the defrosted liquid, so that the meat is not lying in this liquid.

It is particularly important to observe food hygiene rules when defrosting poultry. Do not use the liquid from defrosted poultry. Pour it away and wash the tray, the sink and your hands. Danger of salmonella poisoning!

- Food which does not drip can be placed on the rack or in a dish once the wrapping has been removed.

- Fish does not need to be fully defrosted before cooking. Defrost so that the surface is sufficiently thawed to take herbs and seasoning. Depending on the thickness of the fish, 2 - 5 minutes at 60 °C should be enough.
- When defrosting food which has frozen together, e.g. berries, chops, fish fillets etc separate or break it up about half-way through the defrosting time.
- Allow food to stand at room temperature at the end of the defrosting time. This standing time (see chart) is necessary to ensure that the food is fully defrosted right through to the core.
- Do not refreeze food once it has thawed.
- Defrost deep frozen pre-cooked meals according to the manufacturer's instructions.
- Defrost baked goods in a sealed freezer bag.

Practical tips

Bottling

Select Cook Universal for bottling.

COOK UNIVERSAL function		
Produce	Temp. in °C	Duration in minutes**
Fruit		
Apples	90*	50
Apple sauce/stewed apples	90*	65
Red / Blackcurrants	80*	50
Gooseberries	80*	55
Fruit with stones	85*	55
Vegetables		
Beans	100	120
Gherkins	90*	55

* This temperature is not the same as the recommended temperature.

** The times quoted are for 1.0 litre jars. If using 0.5 litre jars reduce the time by about 15 minutes. If using 0.25 litre jars reduce the time by about 20 minutes.

Proceed as follows:

- Place the condensate tray on the first runner level, and place the rack above it.
- Place a maximum of 6 prepared jars (all the same size) on the rack, ensuring that they do not touch one another. This allows the hot steam to surround the jars on all sides.
- Select and confirm the Cook Universal function.
- Change the recommended temperature if necessary (see chart) and confirm your selection.
- Select the duration (see chart) and confirm your selection.
- Make use of residual heat by leaving the jars in the oven for 30 minutes after it has switched off.
- Cover the jars with a cloth and allow to cool for approx. 24 hours.

Cooking whole meals

It is very economical and practical to cook a whole meal at the same time in the steam oven.

Proceed as follows:

- Place cooking containers on different levels or place them side by side or one on top of the other on the rack.

In general, cooking durations will vary according to the type of food. This means that you will need to open the steam oven at different times to add a particular dish. Our test kitchen recommends the following procedure, as shown in this example (Function: Cook Universal / 100 °C).

Rice	20 minutes
Fish fillet	6 minutes
Broccoli	4 minutes

- First place the dish with the longest cooking duration (the rice), in the oven and set a duration of 20 minutes.
- As soon as the set temperature has been reached, set the minute minder for the difference between the first and second cooking durations, i.e. the time until the second dish has to be placed in the oven (14 minutes). Confirm the minute minder time.
- After 14 minutes, place the second dish (the fish fillet) in the oven.
- As soon as the set temperature has been reached, set the minute minder for the time until the third dish (the broccoli) has to be placed in the oven (2 minutes). Confirm the minute minder time.
- After 2 minutes, place the third dish (the broccoli) in the oven.

At the end of the cooking duration you can remove all the dishes at the same time.

Practical tips

Blanching

You can use your steam oven to blanch vegetables and fruit to prepare them for freezing.

Proceed as follows:

- Put the prepared vegetables/fruit (cleaned, washed, chopped etc.) into a perforated cooking container.
- Select and confirm the Cook Vegetables function. Confirm the recommended temperature of 100 °C.
- Set and confirm a duration of 1 minute.
- Once blanched, plunge the vegetables/fruit into ice cold water to cool them down quickly. Drain them well.

The vegetables/fruit can now be frozen.

Preparing yoghurt

Proceed as follows:

- Mix 100 g yoghurt (with live culture) with 1 litre of fresh milk. The yoghurt and milk should have the same percentage fat content.
If using unpasteurised milk you will need to heat it up to 90 °C (do not boil) and then leave it to cool. Otherwise the yoghurt will not set.
- Pour this milk mixture into 6 or 7 portion sized glass dishes and cover with heat resistant cling film. Special yoghurt jars may also be used.
- Place the covered dishes on the rack.
- Select and confirm Cook Universal and reduce the recommended temperature to 40 °C.
- Set a duration of 5 hours.
- Allow the yoghurt to cool and then place in the refrigerator.

It will not achieve its maximum set until it has been thoroughly chilled.

Disinfecting baby bottles

The steam oven can be used to disinfect baby bottles and other containers. Check beforehand that all parts, teats etc., are declared by the manufacturer to be heat-resistant to 100 °C.

Proceed as follows:

- Place the condensate tray on the lowest shelf level and place the rack above it.
- Dismantle, clean and thoroughly rinse the bottles and space the individual parts out on the rack, ensuring that they do not touch one another. This allows the hot steam to reach them from all sides.
- Select and confirm the Cook Universal function. Confirm the recommended temperature of 100 °C.
- Set and confirm a duration of 15 minutes.
- Dry thoroughly using a fresh, clean tea towel after disinfection. All parts of the bottles must be completely dry before they are reassembled to keep them germ free.

Cleaning and care

General notes

Disconnect the appliance from the electricity supply and allow it to cool down to a safe temperature before cleaning. Clean the whole appliance and then dry it thoroughly after each use.

Make sure the appliance is completely dry before closing the door.

Do not use a steam cleaner to clean this appliance. The steam could reach electrical components and cause a short circuit. Pressurised steam could also cause permanent damage to the surface and to components, for which the manufacturer cannot accept liability.

Do not use cleaners containing alkalines, soda, acids or chlorides, oven sprays, dishwasher cleaner or abrasive cleaning agents, hard brushes, scouring pads and cloths or steel wool. You should also avoid using sponges etc. which have previously been used with abrasive cleaning agents, as these would damage the surface.

Do not use commercial cleaning agents. Only use agents designed for domestic use.

Do not use cleaning agents or washing up liquids containing aliphatics as these could cause the seals to swell.

Appliance front and control panel

The appliance front and controls should be cleaned using a Miele E-Cloth or a mild solution of hot water with a little washing-up liquid, applied with a damp cloth. Then wipe over with clean water, and finally dry with a soft cloth.

See data plate for type of front. N.B. Appliances with glass fronts are fitted with an aluminium handle.

Glass

For appliances with glass fronts, a proprietary glass cleaning agent may be used.

Stainless steel

Stainless steel surfaces can be cleaned using a Miele E-Cloth or with a proprietary non-abrasive cleaning agent designed specifically for use on stainless steel.

To help prevent resoiling, a conditioning agent for stainless steel can also be used.

Follow the manufacturer's instructions.

See "Optional accessories" for details of accessories for cleaning and care.

Aluminium

This material is susceptible to scratching and to damage from alkalis and acids. It is therefore essential to clean it with care, as described above. Do not use cleaning agents for stainless steel or descaling agents on these surfaces. Remove soiling immediately, as leaving it could result in the surface discolouring or altering.

Cleaning and care

Removing the steam oven door

It is much easier to clean the steam oven interior if you remove the door first.

Proceed as follows:

- Open the door fully.
- Flip up the release levers in front of the door hinges.
- Slowly close the door until the raised levers are touching the frame of the oven interior.

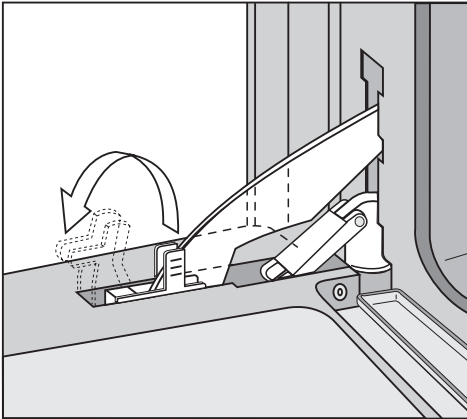

- Holding the door evenly with both hands, lift the door up and off the hinges.

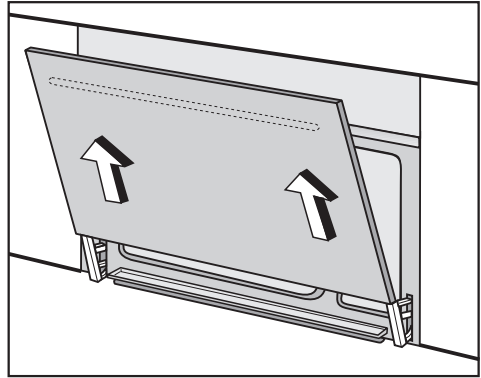

To re-fit the door, reverse the above procedure.

- Fit the door on the hinges.
- Open the door fully.
- Then push the levers back down.
- Close the door.

Oven interior

Dry the oven interior, oven interior roof, door seal, drip channel, inside of the door and the compartment for the water container after each use. Use a sponge or absorbent cloth to wipe off the condensate which has built up.

Remove grease deposits with a mild solution of washing up liquid and warm water and wipe with clean water.

Over time, the floor heater can become discoloured by drops of liquid. This discolouration is easy to remove with a proprietary cleaner for ceramic surfaces, such as the Miele ceramic hob cleaner (see "Optional accessories"). Follow the manufacturer's instructions. After cleaning, wipe the surface with a damp cloth to remove any cleaning agent residues.

The door seal can become porous and brittle over time. If this is the case, it should be replaced with a new seal. Door seals can be ordered from the Miele Spare Parts Department. See back page for contact details.

Condensate tray, rack and cooking containers

The condensate tray, rack and cooking containers should be washed and dried each time they are used.

They are all dishwasher safe.

Automatic door release

Make sure that the door release does not get clogged with food deposits. Wipe off any deposits immediately with a sponge and a mild solution of washing up liquid and warm water. Wipe with clean water.

Side runners

The side runners are easy to remove which makes it easier to clean the sides of the oven.

Proceed as follows:

- Pull on the fixing knob to release it. Remove the runner by first pulling it to the side ① and then out from the back ②.

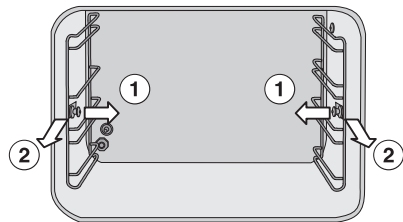

The runners can be cleaned with water and washing up liquid or in a dishwasher.

To re-fit the runners, reverse the above procedure. First fit them into the back of the oven and then push them in at the sides.

Cleaning and care

Water container

Remove, empty and dry the water container after each use. Also remove the insert from the water container.

- Release the insert by pushing the catches on the sides in towards each other and then pull it out of the container.

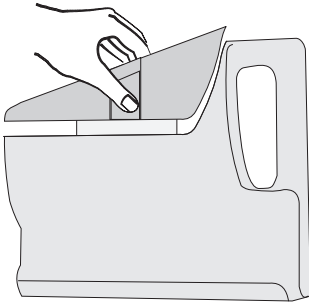

- After cleaning, dry both parts of the insert thoroughly before replacing it in the water container. When replacing the insert (see illustration), guide it in at an angle ① and push the side with the opening downwards ②.

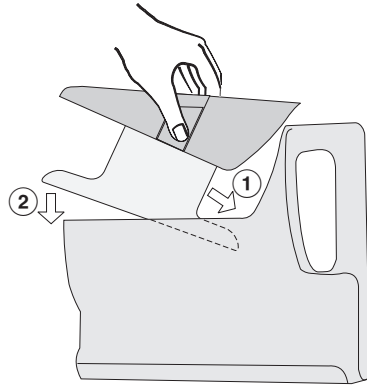

Do not immerse the water container in water or clean it in a dishwasher.

It is important to empty the water container after each use for hygiene reasons, and also to prevent condensate building up in the appliance.

Do not use scouring pads or hard brushes.

Coupling seal

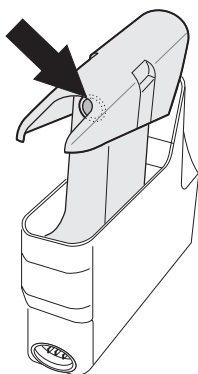

The coupling seal needs to be lubricated regularly. If the water container becomes difficult to remove and replace or the fault message *F20* appears, rub a small amount of the silicone grease supplied (see "Accessories supplied") into the inside of the coupling seal. When doing this, do not detach the seal but leave it in place.

When handling silicone grease, please observe the following safety measures:

- Remove any silicone grease from your skin either by wiping it off or by washing it off.
- If the grease gets into the eyes it must be rinsed out with plenty of clean water.
- If it is swallowed, seek medical advice.

The coupling seal should be replaced with a new one if it becomes brittle or porous over time or if an unusually large amount of water collects on the floor of the water container compartment.

Coupling seals can be ordered from the Miele Spare Parts Department. See back page for contact details.

Only use the silicone grease supplied. On no account must margarine or oil or any other domestic grease or fat be used, as these can cause the seal to swell.

Cleaning and care

Descaling

Use the descaling tablets supplied with the appliance (see "Optional accessories" for reordering details) or a proprietary citric acid based descaling agent to descale the appliance. Follow the manufacturer's instructions.

With aluminium appliances (see data plate) ensure that the descaling agent does not come into contact with the aluminium surfaces as this could cause marks. If, however, any descaling agent gets onto an aluminium surface, wipe it away immediately.

The water container will need descaling after a certain number of operating hours. The display will alert you when this needs done.



Please descale the steam oven
Number of uses until appliance locks out: 10

The appliance will lock out after you use it for the tenth time.

If you want to descale the appliance before it locks out, you can select the Descale function.



Please fill with descaling agent

- Fill the water container with 1 litre of descaling solution. To make the solution, use cold water and descaling tablets, as instructed on the packet, or the appropriate amount of citric acid based household descaling agent.
- Push the water container into position and press the multi-function selector.



- Confirm "Start".

It is only possible to cancel the descaling process during the first few minutes (before the  lights up). After that the process cannot be cancelled.

Do not switch the appliance off during the descaling process. If it is switched off before the end of the process, the whole process will have to be started from the beginning again.

After 12 minutes, the appliance will prompt you to fill it with fresh water.

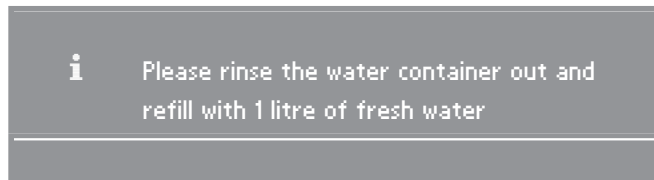

- Remove the water container and empty it. Remove the insert.
- Rinse the water container and the insert thoroughly.
- Replace the insert and fill the water container with 1 litre of water. Push the water container into the appliance until it connects.
- Confirm "Start".

After descaling:

- Open the door.
- Remove the water container and empty it.
- Switch the appliance off, and then dry it thoroughly.

Problem solving guide

Installation work and repairs to electrical components of this appliance must only be carried out by a suitably qualified and competent person in accordance with local and national safety regulations. Repairs and other work by unqualified persons could be dangerous. The manufacturer cannot be held liable for unauthorised work.

What to do if:

... you cannot switch the appliance on.

Check whether the mains fuse has blown.

If this is not the case, then disconnect the appliance from the electricity supply for approx. 1 minute. To do this:

- switch off at the wall socket and withdraw the plug, or
- switch off at the isolator, or
- withdraw the mains fuse.

Reconnect to the mains supply and switch the appliance on. If it still will not start, contact a qualified electrician or the Miele Service Department.

... the fan can still be heard after the appliance has been switched off.

The appliance is fitted with a fan which removes steam from the oven. The fan will continue to run for a while after the appliance has been switched off.

... the water container has become harder to put into the appliance and take out again.

Lightly lubricate the coupling seal on the water container with silicone grease, as described in "Coupling seal".

... the heating-up phase lasts an unusually long time.

Check the bottom of the water container.

If a thick layer of limescale has built-up, check the water hardness level that has been set. Set the correct water hardness level for your water supply (see "Setting the water hardness") and descale the appliance as described in "Descaling".

If the water hardness level was in fact set correctly or the problem occurs again, contact the Service Department.

... after moving house the appliance no longer switches from the heating-up phase to the cooking phase.

Altitude affects the boiling point of water. The appliance must be reset to take into account the different water boiling point in its new location (see "Cleaning and heating up for the first time".)

... during operation an unusually large amount of steam escapes or steam escapes from parts of the steam oven where it does not usually.

Check whether

- the door is closed properly.
- the door seal is fitted correctly. If necessary, press it in all the way round the door to make sure it is fitted evenly.
- the door seal is damaged, e.g. cracks can be seen. The seal must be replaced with a new one.

If this does not solve the problem, call the Miele Service Department.

... a whistling sound is heard when the appliance is switched on again.

When the door is closed, the pressure has to equalise, which can cause a whistling sound. This is not a fault.

.... F and a number appear in the display.

This combination indicates a fault.

- F 20: The appliance does not heat up.

First of all, check whether the water container has been pushed right into the appliance so that it connects. Then switch the appliance off and then back on again.

If the fault occurs again, lightly lubricate the coupling seal on the water container with silicone grease, as described in "Coupling seal".

If the appliance still will not start, switch it off and contact the Miele Service Department.

- Other fault messages:

Call the Service department.

After sales service, data plate

In the event of any faults which you cannot remedy yourself, please contact:

- your Miele dealer, or
- the Miele Service Department (see address on back cover).

When contacting your Dealer or the Service Department, please quote the model and serial number of your appliance. These are on the data plate.

Please note that telephone calls may be monitored and recorded for training purposes

Space in which to stick the extra data plate supplied with the appliance. Ensure that the model number is the same as the one on the front of these operating instructions.

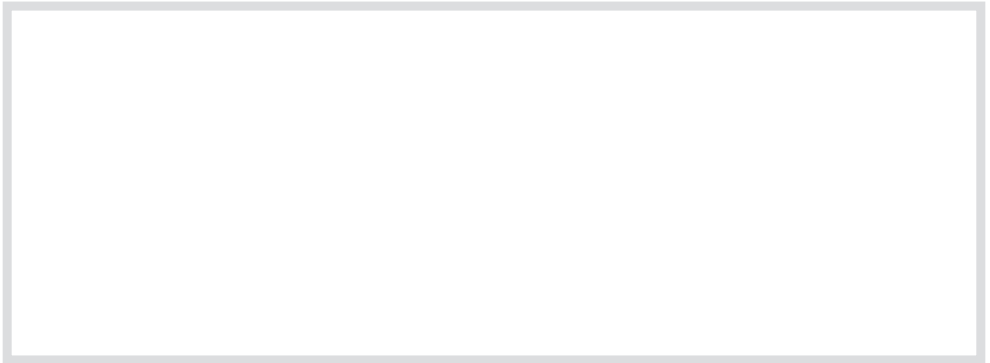

Safety instructions for installation

All dimensions are given in mm.

■ Before connecting the appliance to the mains supply make sure that the voltage and frequency correspond to the rating on the data plate.

This data must correspond in order to avoid the risk of damage to the appliance. Consult a qualified electrician if in any doubt.

■ The socket and on-off switch should be easily accessible after the appliance has been built in.

■ This equipment may only be used in mobile installations such as ships, caravans, aircraft etc. if a risk assessment of the installation has been carried out by a suitably qualified engineer.

■ The appliance must be installed in a such a position that you can see the contents of a cooking container placed on the top runner. Otherwise you may risk scalding or burning yourself with hot water and food when taking containers out of the oven.

Installation

Appliance and building-in dimensions

Installation in a tall unit

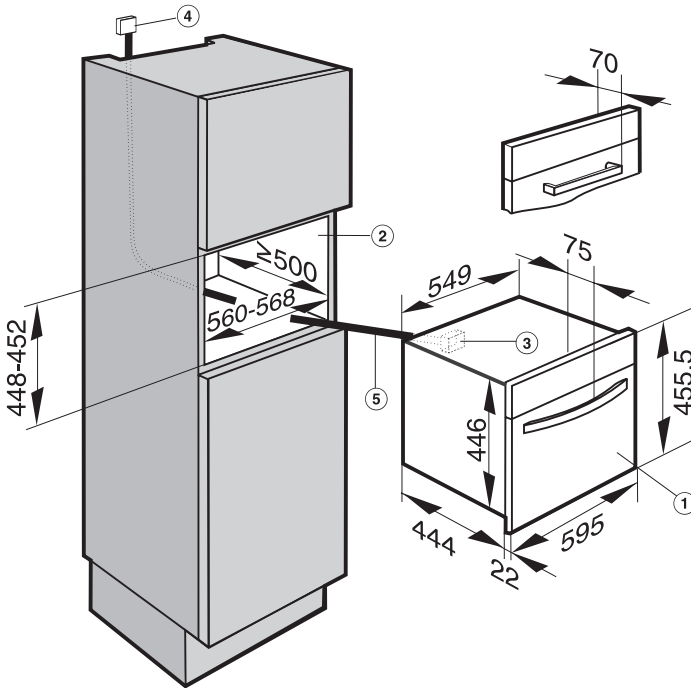

- ① Steam oven
- ② Building-in recess
- ③ Inlet for mains connection cable to the appliance
- ④ Recommended position for electrical socket.
Important: Do not position behind the appliance!
- ⑤ Mains connection cable

Installation in a base unit

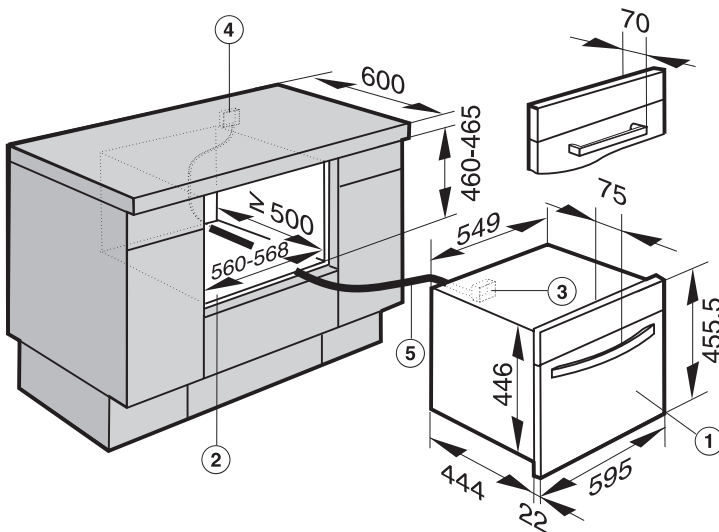

- ① Steam oven
- ② Building-in recess
- ③ Inlet for mains connection cable to the appliance
- ④ Recommended position for electrical socket.
Important: Do not position behind the appliance!
- ⑤ Mains connection cable

N.B. Undercounter installation is not recommended if there are young children in the home.

Installation

Installation in a tall unit in combination with an oven

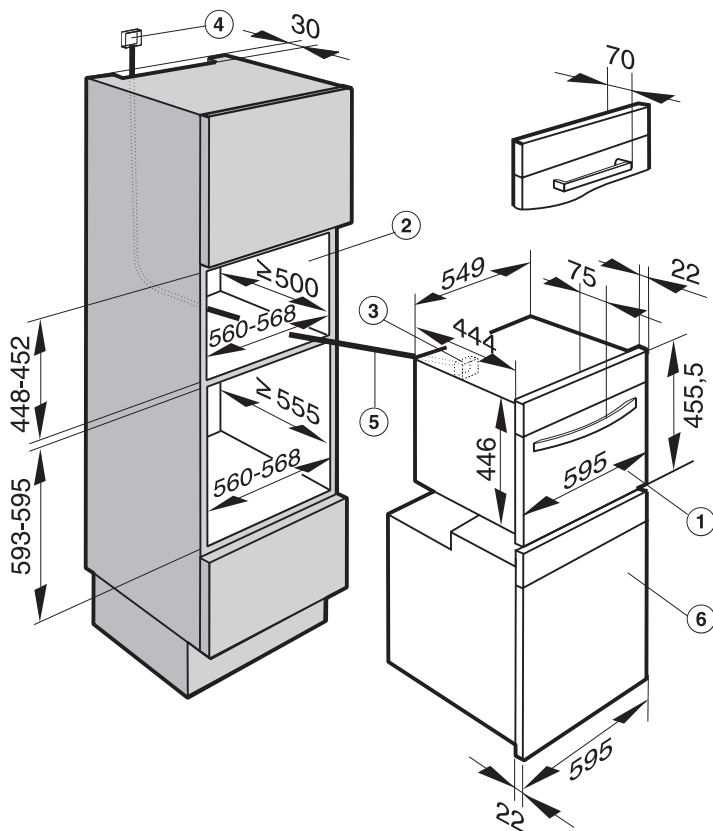

- ① Steam oven
- ② Building-in recess
- ③ Inlet for mains connection cable to the appliance
- ④ Recommended position for electrical socket.
Important: Do not position behind the appliance!
- ⑤ Mains connection cable
- ⑥ Oven

Installing the appliance

- Push the appliance into the recess. After aligning the appliance it must be secured against slippage. Do this by screwing the two 3.5 x 25 mm wood screws ⑨ (supplied) into the vertical strips on either side of the appliance (see illustration).

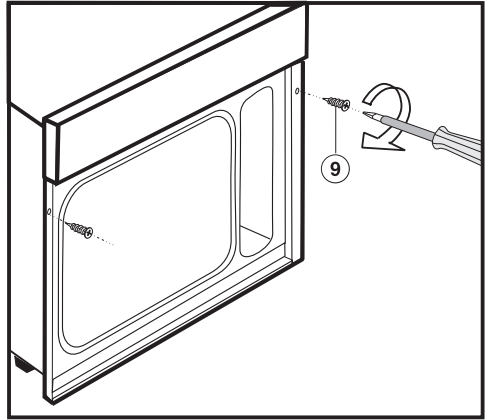

Installation

Electrical connection

All electrical work should be carried out by a suitably qualified and competent person, in strict accordance with current local and national safety regulations (BS 7671 in the UK).

Installation, repairs and other work by unqualified persons could be dangerous. The manufacturer cannot be held liable for unauthorised work.

Ensure power is not supplied to the appliance until after installation work has been carried out.

The appliance must only be operated when built-in. This is to ensure that all electrical parts are shielded. Live parts must not be exposed.

Do not connect the appliance to the mains electricity supply via an extension lead. These do not guarantee the required safety of the appliance.

Please ensure that the connection data quoted on the data plate match the household mains supply.

Connection should be made via a suitable isolator or a double pole fused spur connection unit or fused plug and switched socket which complies with national and local safety regulations and the on/off switch should be easily accessible after the appliance has been built in.

If the switch is not accessible after installation (depending on country) an additional means of disconnection must be provided for all poles.

For extra safety it is advisable to install a residual current device (RCD), with a trip current of 30 mA.

When switched off there must be an all-pole contact gap of 3 mm in the isolator switch (including switch, fuses and relays).

Important U.K.

This appliance is supplied for connection to a single phase 230-240 V 50 Hz supply with a 3-core cable.

The wires in the mains lead are coloured in accordance with the following code:

Green/yellow = earth

Blue = neutral

Brown = live

**WARNING: THIS APPLIANCE
MUST BE EARTHED**

Non-rewireable plugs BS 1363

The fuse cover must be refitted when changing the fuse, and if the fuse cover is lost, the plug must not be used until a suitable replacement is obtained. The colour of the correct replacement cover is that of the coloured insert in the base of the plug, or the colour that is embossed in words on the base of the plug (as applicable to the design of plug fitted).

Replacement fuses should be ASTA approved to BS 1362 and have the correct rating. Replacement fuses and fuse covers may be purchased from your local electrical supplier.

Important

The electrical safety of this appliance can only be guaranteed when continuity is complete between the appliance and an effective earthing system, which complies with local and national regulations. It is most important that this basic safety requirement is tested regularly and where there is any doubt the household wiring should be inspected by a qualified electrician. The manufacturer cannot be held liable for the consequences of an inadequate earthing system such as electric shock.

The manufacturer cannot be held liable for damage caused by incorrect installation or connection.

United Kingdom:

Miele Co. Ltd.
Fairacres, Marcham Road
Abingdon, Oxon, OX14 1TW
Tel.: (01235) 554455
Fax.: (01235) 554477
Service Office Tel.: (08707) 554466
E-mail: info@miele.co.uk
Internet: www.miele.co.uk

Ireland:

Miele Ireland Ltd.
Broomhill Road, Tallaght, Dublin 24
Tel: (01) 46 10 710, Fax: (01) 46 10 797
Email: info@miele.ie
Internet: <http://www.miele.ie>

Australia:

Miele Australia Pty. Ltd.
A.C.N. 005635398
1 Gilbert Park Drive
Knoxfield, VIC 3180
Telephone: (03) 9764 7100
Fax: (03) 9764 7129
Internet: www.miele.com.au

Distributor New Zealand:

Steelfort Engineering Company. Ltd.
500 Rangitikei Street
Palmerston North, Priv. Bag 11045, NZ
Telephone: (06) 350 1350
Fax: (06) 356 1507

South Africa:

Miele (Pty) Ltd
63 Peter Place
Bryanston 2194
P.O. Box 69434
Bryanston 2021
Tel.: (011) 548 1900
Telefax (011) 548 1935
E-mail: info@miele.co.za
Internet: www.miele.co.za

Singapore:

Miele Southeast Asia
Miele Pte. Ltd.
163 Penang Road
04 - 02/03 Winsland House II
Singapore 238463
Tel : +65-67351191
Fax: +65-67351161
Email: infosea@miele.com.sg
Internet: www.miele.sg

Hong Kong:

Miele (Hong Kong) Limited
AIA Plaza, 24th Floor
18 Hysan Avenue
Causeway Bay
Hong Kong
Tel.: (852) 2610 1331
Fax: (852) 2610 1013
E-mail: mielehk@miele.com.hk